



*Meubles de Qualité à Prix Abordable  
Affordable Quality Home Furniture*

**BUREAU D'ORDINATEUR 48"L BLANC  
WHITE 48"L COMPUTER DESK**

**I 7053**

**INSTRUCTIONS D'ASSEMBLAGE  
ASSEMBLY INSTRUCTIONS**

**MONARCH SPECIALTIES INC.**

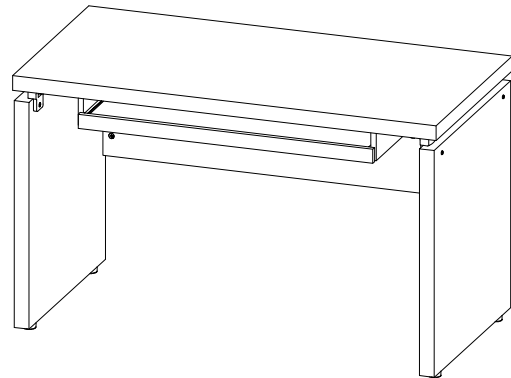

**POUR DE L'ASSISTANCE OU POUR COMMANDER  
DES PIÈCES CONTACTEZ NOTRE DÉPARTEMENT  
DE SERVICE À LA CLIENTÈLE.**





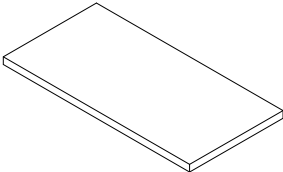
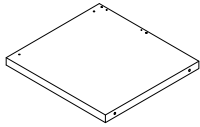
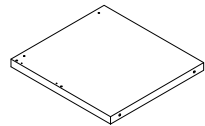
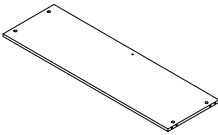
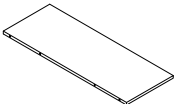
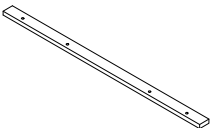
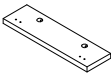
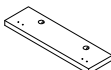

**FOR ASSISTANCE OR TO ORDER PARTS  
CONTACT OUR CUSTOMER SERVICE DEPARTMENT**

**[WWW.MONARCHSERVICE.COM](http://WWW.MONARCHSERVICE.COM)**

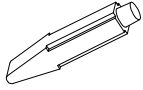
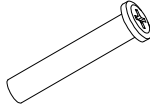
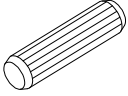
**IDENTIFICATION DES PIÈCES**  
**PARTS IDENTIFICATION**

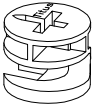
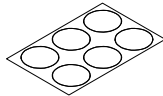
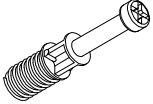
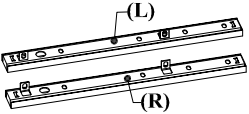
<b>(1)</b>		<b>PANNEAU DU DESSUS</b> <b>TOP PANEL</b>	<b>1MC</b> <b>1PC</b>
<b>(2)</b>		<b>PANNEAU DU CÔTÉ GAUCHE</b> <b>LEFT SIDE PANEL</b>	<b>1MC</b> <b>1PC</b>
<b>(3)</b>		<b>PANNEAU DU CÔTÉ DROIT</b> <b>RIGHT SIDE PANEL</b>	<b>1MC</b> <b>1PC</b>
<b>(4)</b>		<b>PANNEAU ARRIÈRE</b> <b>BACK PANEL</b>	<b>1MC</b> <b>1PC</b>
<b>(5)</b>		<b>TABLETTE DE CLAVIER</b> <b>KEYBOARD SHELF</b>	<b>1MC</b> <b>1PC</b>
<b>(6)</b>		<b>REBORD DE TABLETTE DE CLAVIER</b> <b>KEYBOARD FRONT CROSS BAR</b>	<b>1MC</b> <b>1PC</b>
<b>(7)</b>		<b>PANNEAU DE LA DIVISION GAUCHE</b> <b>LEFT DIVIDER PANEL</b>	<b>1MC</b> <b>1PC</b>
<b>(8)</b>		<b>PANNEAU DE LA DIVISION DROITE</b> <b>RIGHT DIVIDER PANEL</b>	<b>1MC</b> <b>1PC</b>

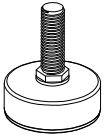
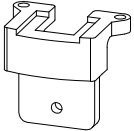
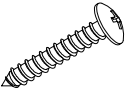
**IDENTIFICATION DES PIÈCES DE MONTAGE**  
**HARDWARE IDENTIFICATION**

<b>A</b>		<b>COLLE/GLUE</b>	<b>1MC/PC</b>	<b>K</b>		<b>∅ 6.2x45mm</b>	<b>4MCX/PCS</b>
<b>B</b>		<b>∅ 8x30mm</b>	<b>12MCX/PCS</b>	<b>L</b>		<b>∅ 6.2x18mm</b>	<b>1MC/PC</b>
<b>C</b>		<b>∅ 15x12mm</b>	<b>8MCX/PCS</b>	<b>M</b>			<b>2MCX/PCS</b>
<b>D</b>		<b>∅ 7x35.5mm</b>	<b>8MCX/PCS</b>				
<b>E</b>		<b>L 300mm</b>	<b>1 ENS/SET</b>				
<b>F</b>		<b>∅ 3.5x12.5mm</b>	<b>12MCX/PCS</b>				
<b>G</b>			<b>4MCX/PCS</b>				
<b>H</b>			<b>5MCX/PCS</b>				
<b>I</b>		<b>∅ 4.2x25.4mm</b>	<b>10MCX/PCS</b>				
<b>J</b>		<b>∅ 4.5x12mm</b>	<b>5MCX/PCS</b>				

ÉTAPE / STEP 1

La colle (A) doit être utilisée aux endroits indiqués afin de solidifier l'étagère assemblée.  
 The Glue (A) should be used in the indicated locations to help solidify the assembled unit.

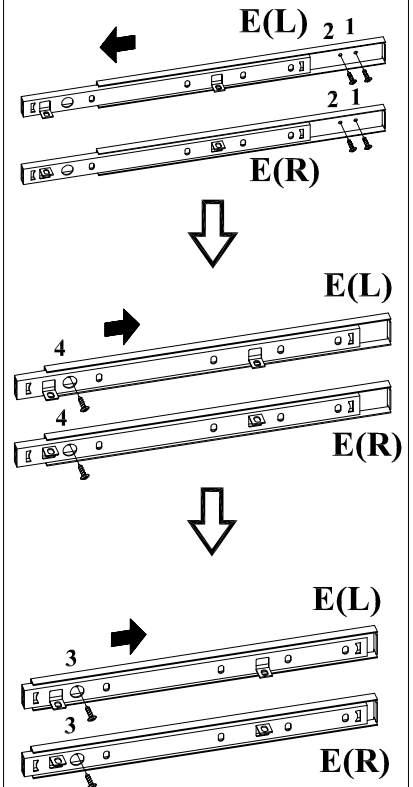
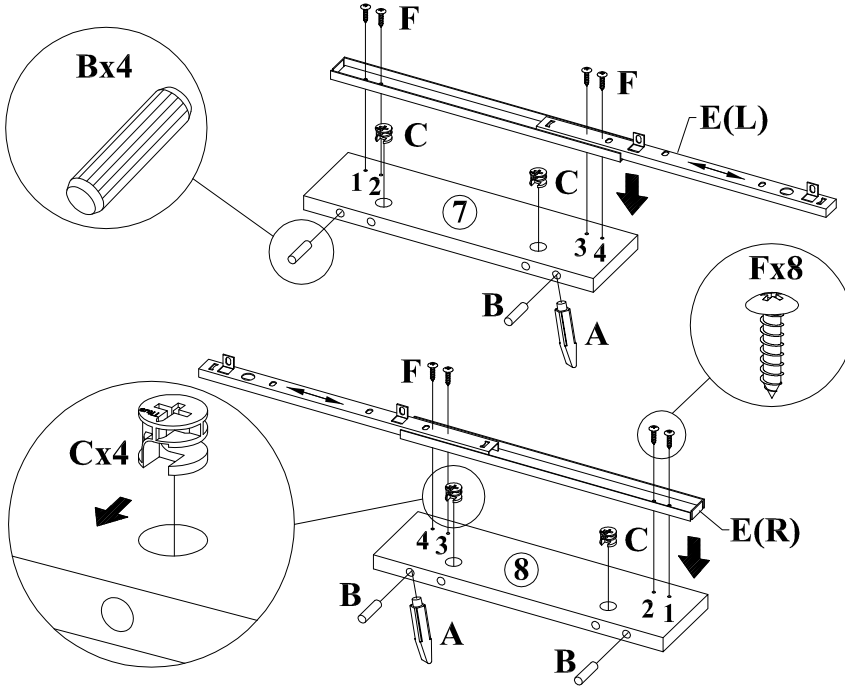

ÉTAPE / STEP 2

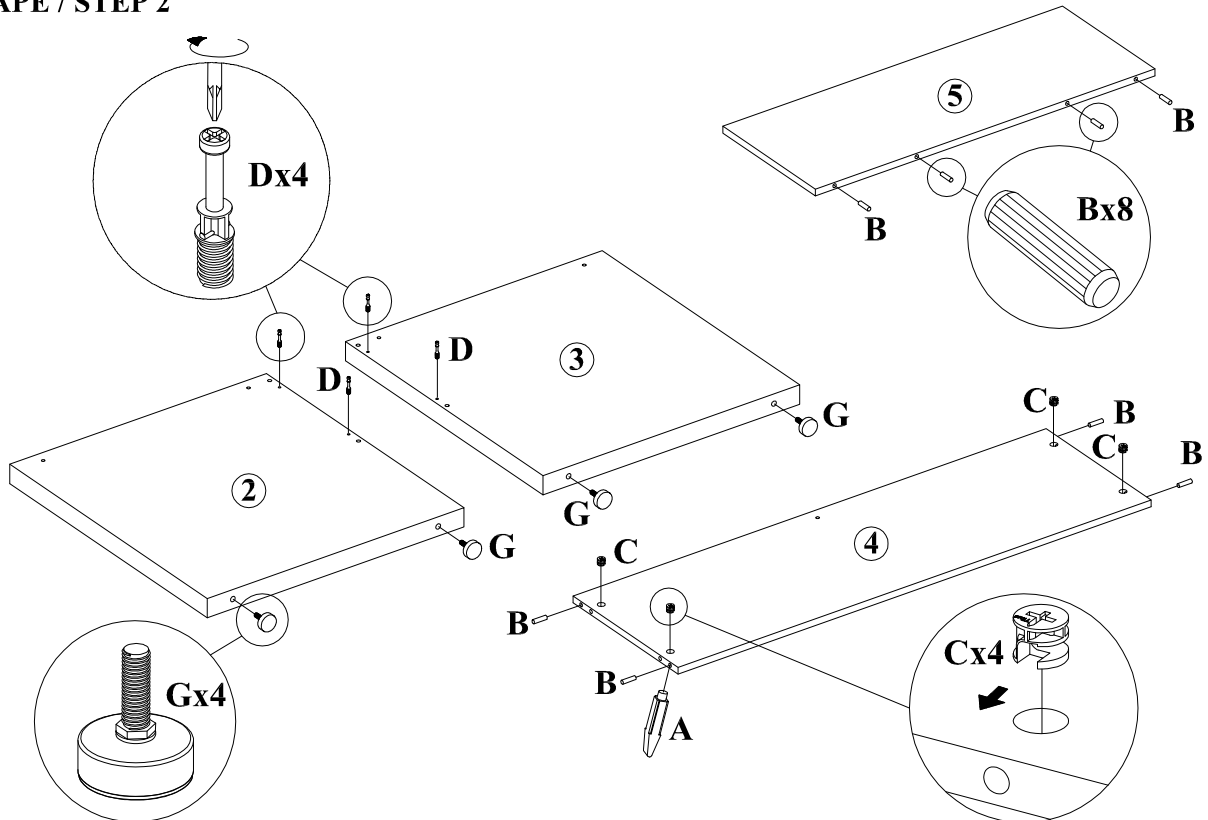

ÉTAPE / STEP 3

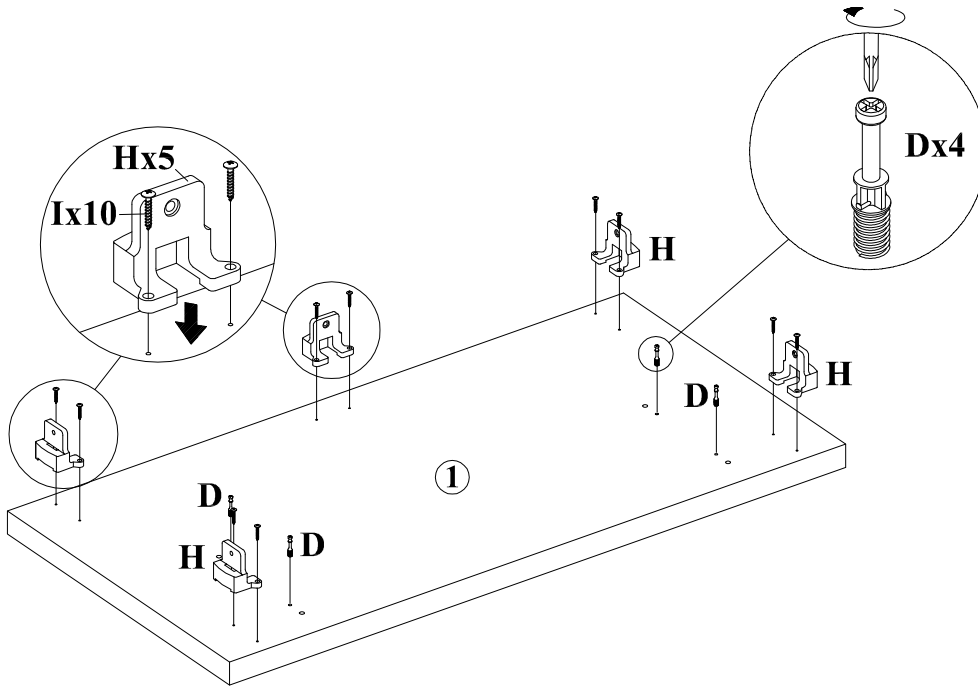

ÉTAPE / STEP 4

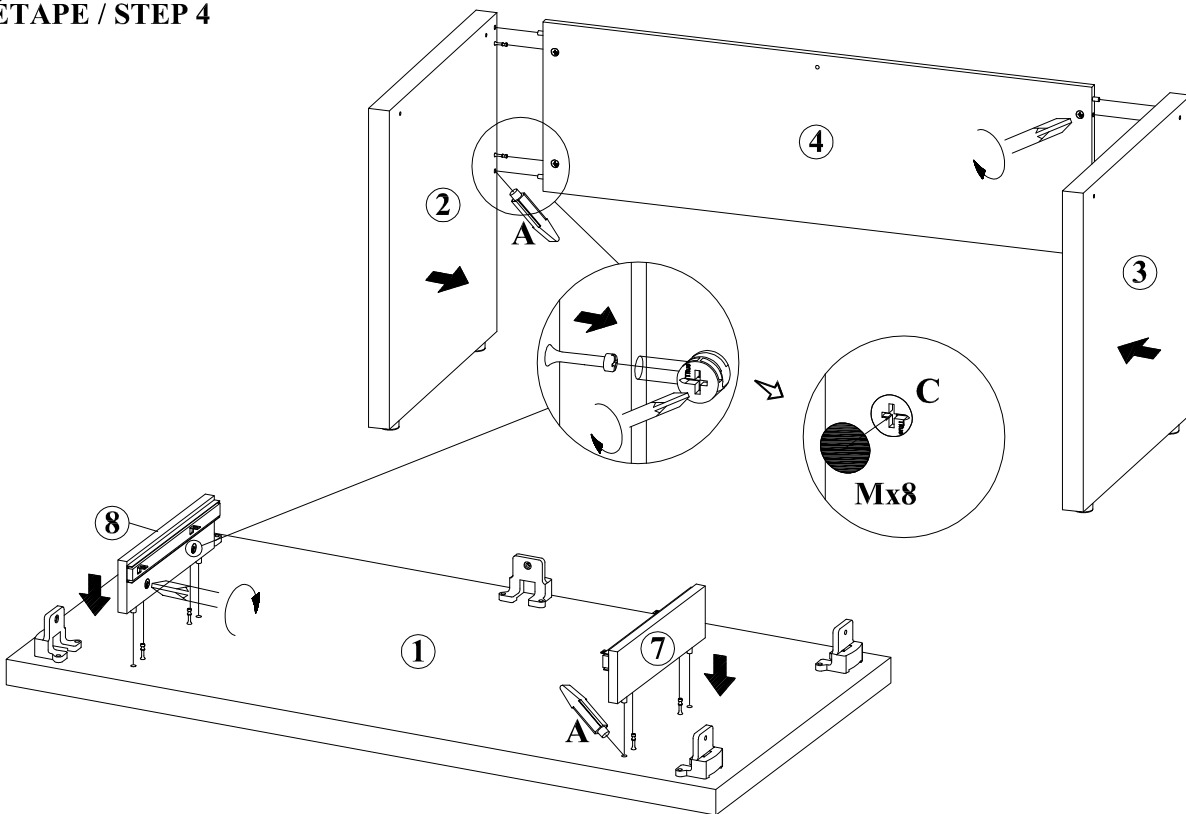

ÉTAPE / STEP 5

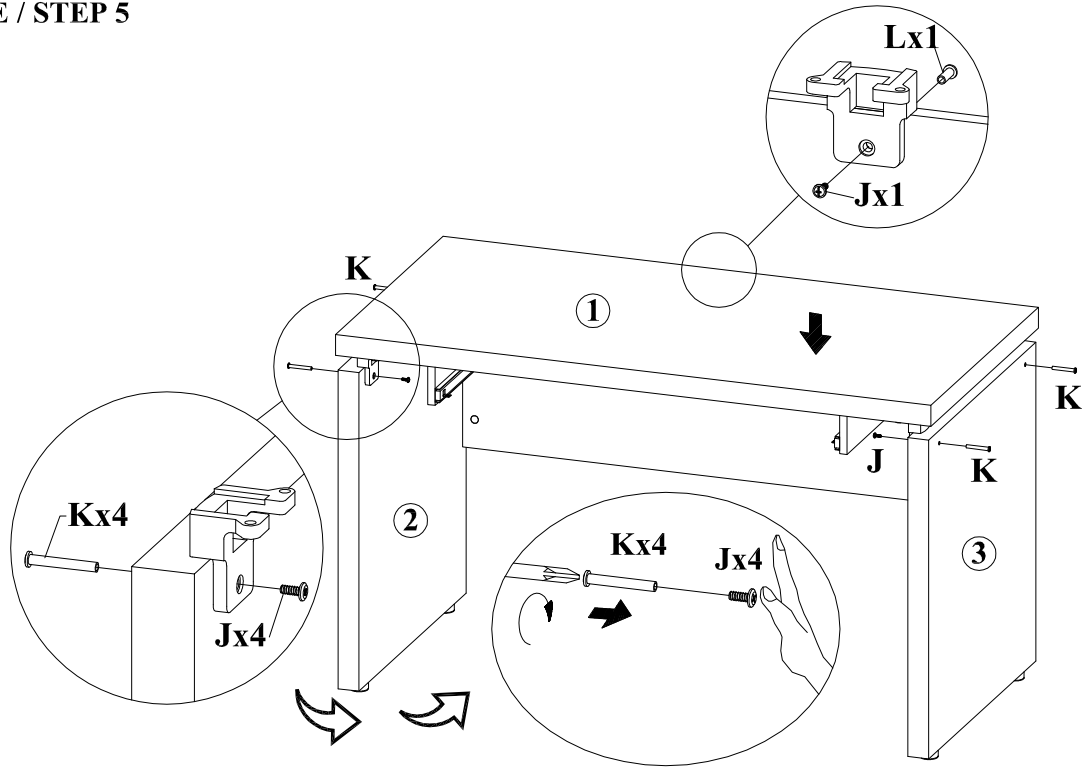

ÉTAPE / STEP 6

La colle (A) doit être utilisée aux endroits indiqués afin de solidifier l'étagère assemblée.  
 The Glue (A) should be used in the indicated locations to help solidify the assembled unit.

