



BANC 48" L AVEC 3 TIROIRS BOIS SOLIDE CAPPUCCINO
CAPPUCCINO SOLID WOOD 48" L BENCH WITH 3 DRAWERS

I 4524

INSTRUCTIONS D'ASSEMBLAGE
ASSEMBLY INSTRUCTIONS









POUR DE L'ASSISTANCE OU POUR COMMANDER
DES PIÈCES CONTACTEZ NOTRE DÉPARTEMENT
DE SERVICE À LA CLIENTÈLE.

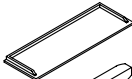
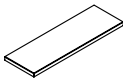
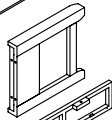

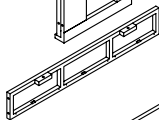

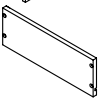

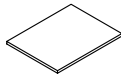







FOR ASSISTANCE OR TO ORDER PARTS
CONTACT OUR CUSTOMER SERVICE DEPARTMENT

WWW.MONARCHSERVICE.COM

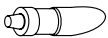
IDENTIFICATION DES PIÈCES
PARTS IDENTIFICATION

1		PANNEAU DU DESSUS TOP PANEL	1 MC 1 PC	6		COUSSIN DE SIÈGE CUSHION SEAT	1 MC 1 PC
2		LANGUETTE DE CÔTÉ SIDE STRETCHER	1 MC 1 PC	7		PANNEAU DEVANT DU TIROIR DRAWER FRONT PANEL	3 MCX 3 PCS
3		LANGUETTE AVANT FRONT STRETCHER	1 MC 1 PC	8		PANNEAU ARRIÈRE DU TIROIR DRAWER BACK PANEL	3 MCX 3 PCS
4		PANNEAU ARRIÈRE BACK PANEL	1 MC 1 PC	9		PANNEAU CÔTÉ DU TIROIR DRAWER SIDE PANEL	6 MCX 6 PCS
5		PANNEAU DU BAS BOTTOM PANEL	1 MC 1 PC	10		PANNEAU FOND DU TIROIR DRAWER BOTTOM PANEL	3 MCX 3 PCS

IDENTIFICATION DES PIÈCES DE MONTAGE
HARDWARE IDENTIFICATION

A		Ø1/4"	2 MCX 2 PCS	J		20 x 20MM	3 MCX 3 PCS
B		Ø5/8"	2 MCX 2 PCS	K		40 x 60MM	3 MCX 3 PCS
C		Ø8 x 30mm	18 MCX 18 PCS	L		3 x 12mm	21 MCX 21 PCS
D		1/4"	1 MC 1 PC	M		1/4" x 1-1/4"	10 MCX 10 PCS
E		20G	1 MC 1 PC	N		1/4"	10 MCX 10 PCS
F		Ø8 x 1"	24 MCX 24 PCS	O		Ø15MM	3 MCX 3 PCS
H		20 x 60MM	3 MCX 3 PCS	P		5/32" x 1"	3 MCX 3 PCS
I		20 x 20MM	3 MCX 3 PCS				

ÉTAPE/STEP 1

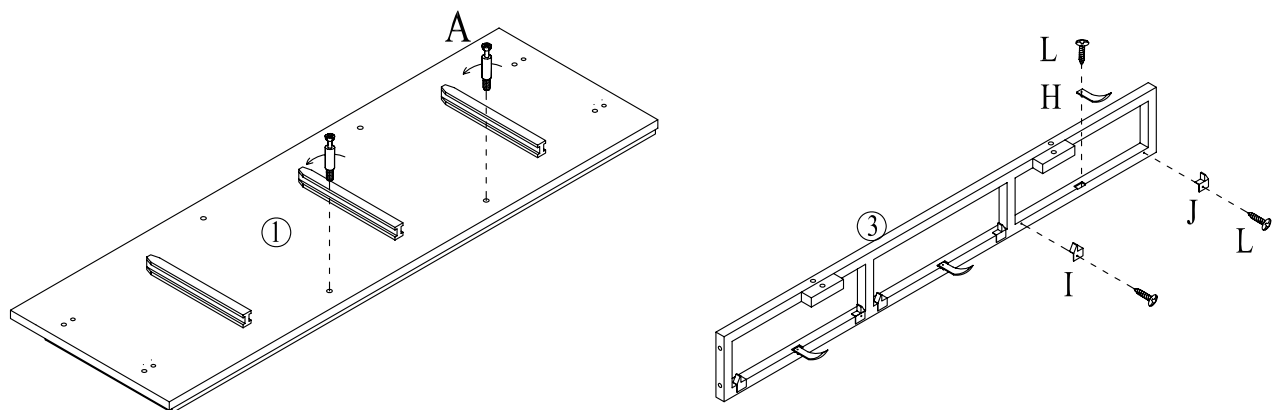

ÉTAPE/STEP 2

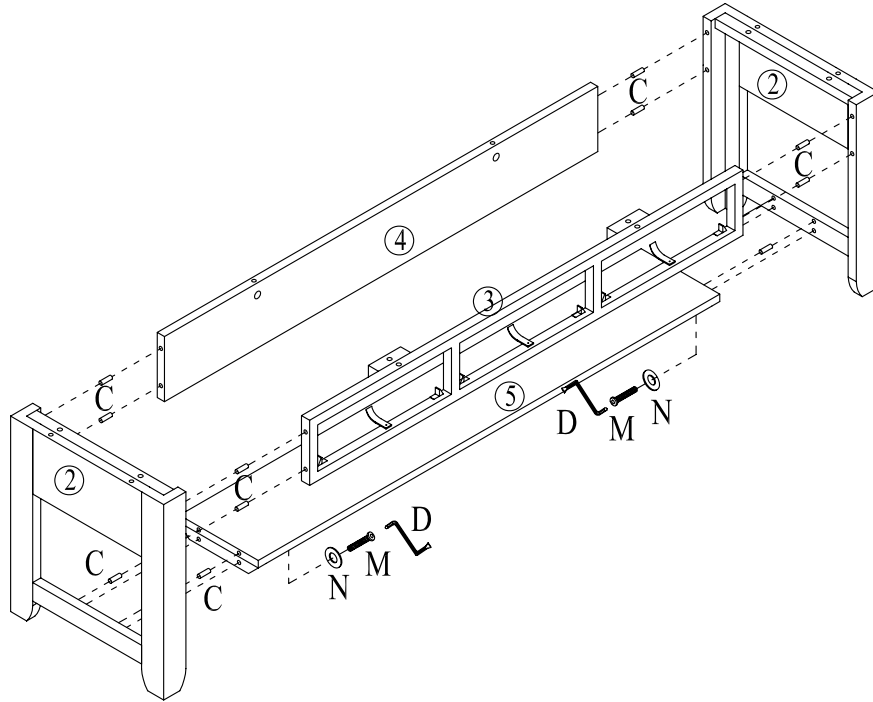

ÉTAPE/STEP 3

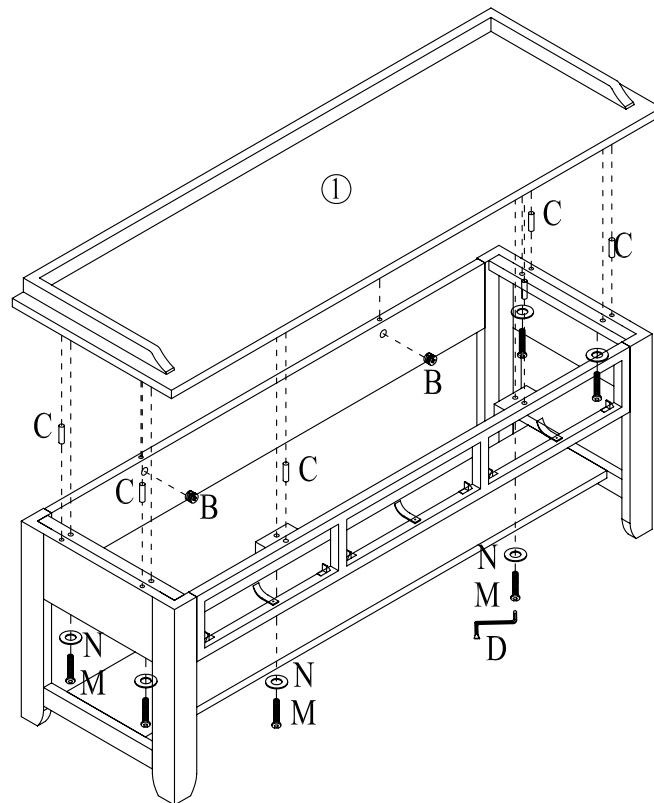

ÉTAPE/STEP 4

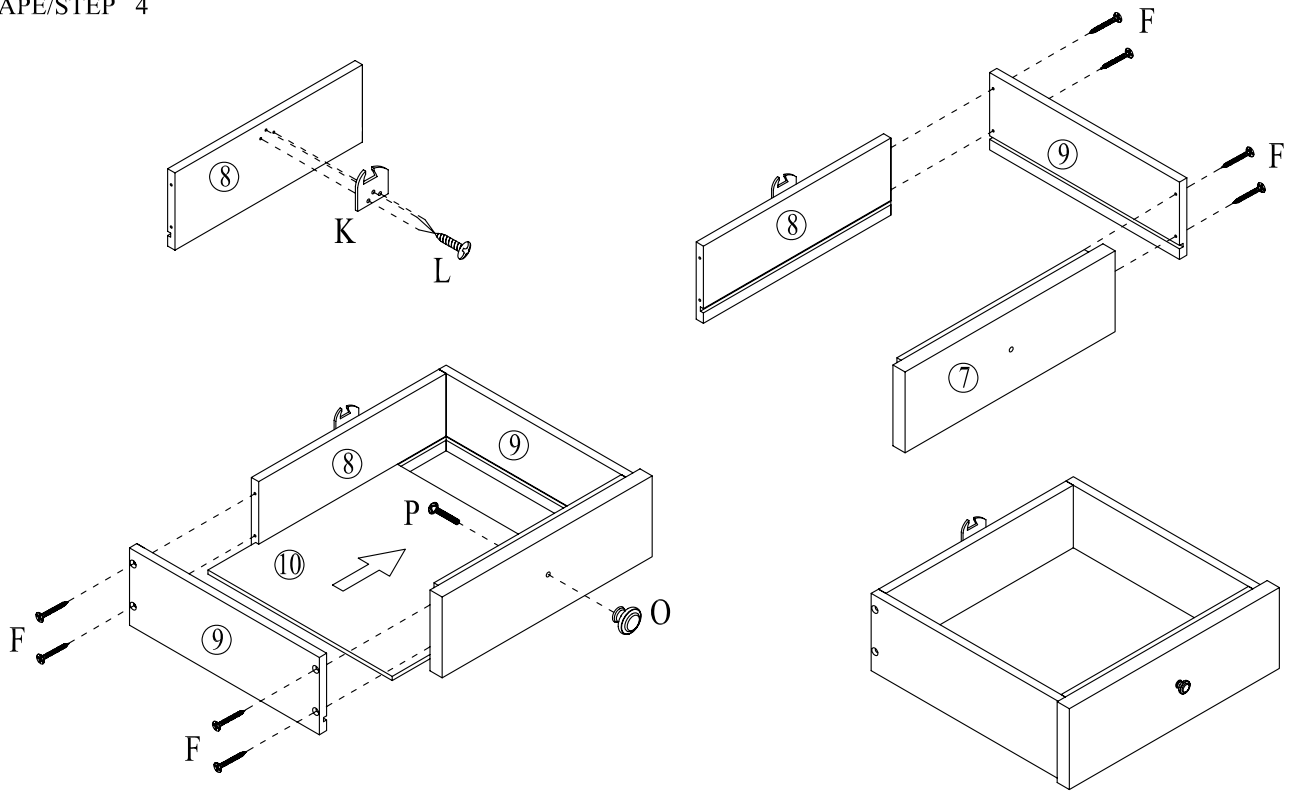

ÉTAPE/STEP 5

