



*Meubles de Qualité à Prix Abordable
Affordable Quality Home Furniture*

**TABLETTE MURALE 24"H CAPPUCCINO
CAPPUCCINO 24"H WALL MOUNT SHELF**

I 3436

**INSTRUCTIONS D'ASSEMBLAGE
ASSEMBLY INSTRUCTIONS**

MONARCH SPECIALTIES INC.



**POUR DE L'ASSISTANCE OU POUR COMMANDER
DES PIÈCES CONTACTEZ NOTRE DÉPARTEMENT
DE SERVICE À LA CLIENTÈLE.**







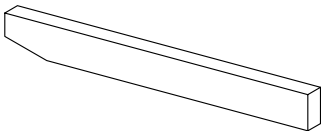
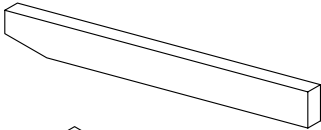
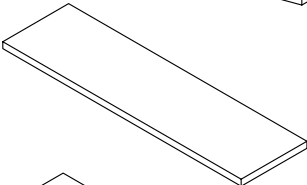
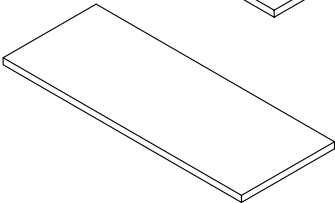
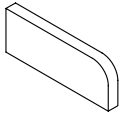
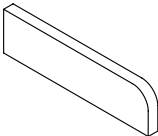
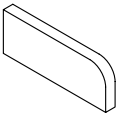
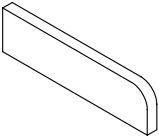
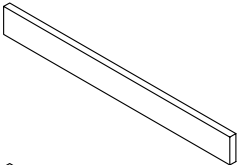
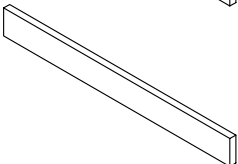

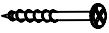

**FOR ASSISTANCE OR TO ORDER PARTS
CONTACT OUR CUSTOMER SERVICE DEPARTMENT**

WWW.MONARCHSERVICE.COM

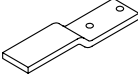
IDENTIFICATION DES PIÈCES
PARTS IDENTIFICATION

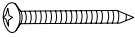
1		PATTE GAUCHE LEFT LEG	1MC/PC
2		PATTE DROIT RIGHT LEG	1MC/PC
3		TABLETTE SHELF	1MC/PC
4		TABLETTE SHELF	1MC/PC
5		PANNEAU CÔTÉ GAUCHE LEFT SIDE PANEL	1MC/PC
6		PANNEAU CÔTÉ GAUCHE LEFT SIDE PANEL	1MC/PC
7		PANNEAU CÔTÉ DROIT RIGHT SIDE PANEL	1MC/PC
8		PANNEAU CÔTÉ DROIT RIGHT SIDE PANEL	1MC/PC
9		BARRE TRANSVERSALE CROSSBAR	2MCX/PCS
10		BARRE TRANSVERSALE CROSSBAR	1MC/PC

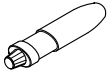
IDENTIFICATION DES PIÈCES DE MONTAGE
HARDWARE IDENTIFICATION

A		Ø4×30mm	20MCX/PCS
B		Ø4×35mm	8MCX/PCS
C		Ø8×25mm	10MCX/PCS
D		Ø4.2x65mm	8MCX/PCS
E		Ø13mm	24MCX/PCS
F		65x15x3mm	2MCX/PCS
G		30x18x18mm	2MCX/PCS
H		Ø4x12mm	4MCX/PCS
I		Ø5x40mm	4MCX/PCS
J		Ø8x40mm	4MCX/PCS
K		10g	1MC/PC
L		L1500mm	1MC/PC

ÉTAPE / STEP 1

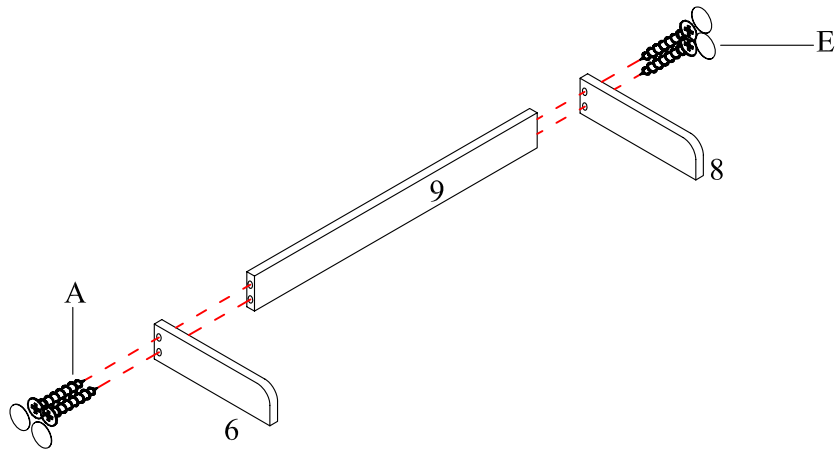

ÉTAPE / STEP 2

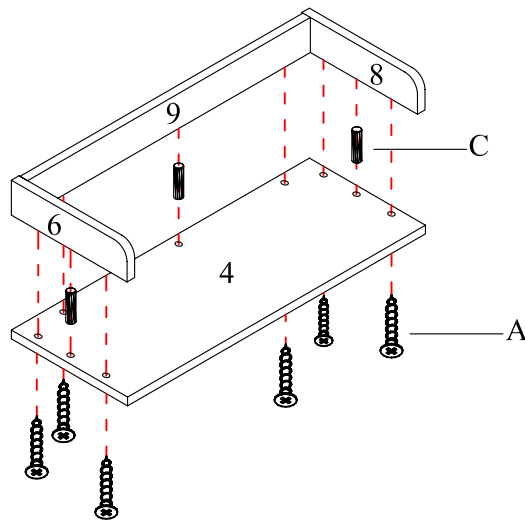

ÉTAPE / STEP 3

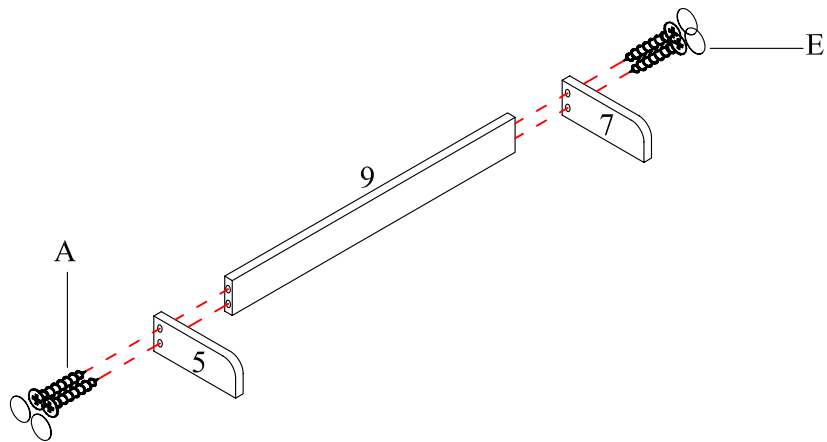

ÉTAPE / STEP 4

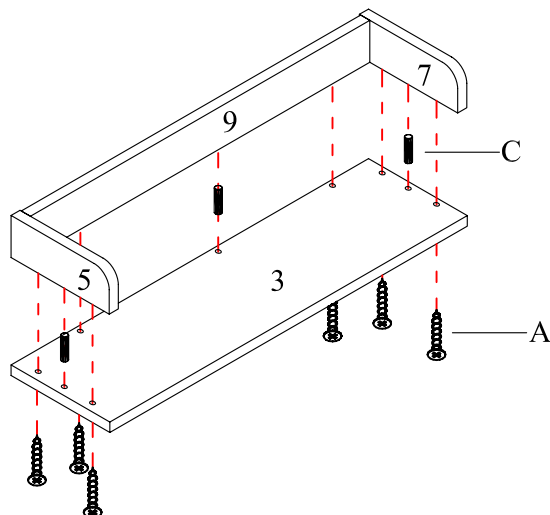

ÉTAPE / STEP 5

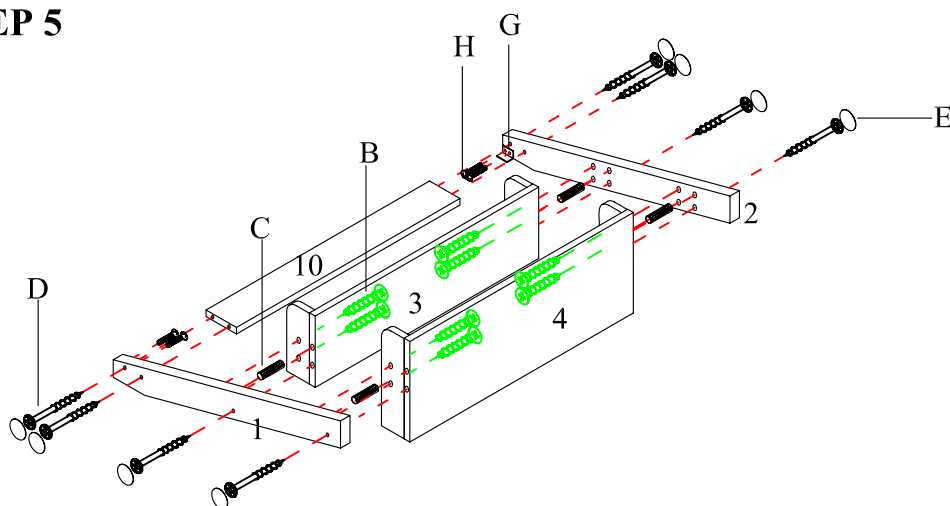

ÉTAPE / STEP 6

