

MONARCH
SPECIALTIES INC.

*Meubles de Qualité à prix Abordable
Affordable Quality Home Furniture*

**ÉTAGÈRE EN COIN 33"H MÉTAL NICKEL SATINÉ /
VERRE TREMPÉ**

**SATIN NICKEL METAL 33"H ETAGERE WITH
TEMPERED GLASS**

I 3427

**INSTRUCTIONS D'ASSEMBLAGE
ASSEMBLY INSTRUCTIONS**

MONARCH SPECIALTIES INC.

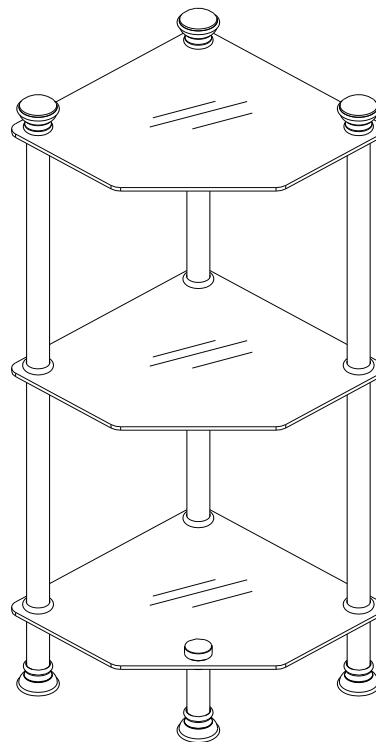



**POUR DE L'ASSISTANCE OU POUR COMMANDER
DES PIÈCES CONTACTEZ NOTRE DÉPARTEMENT
DE SERVICE À LA CLIENTÈLE.**





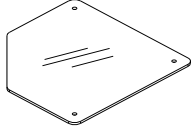
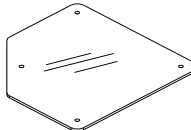
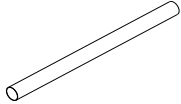



**FOR ASSISTANCE OR TO ORDER PARTS
CONTACT OUR CUSTOMER SERVICE DEPARTMENT**

WWW.MONARCHSERVICE.COM

IDENTIFICATION DES PIÈCES
PARTS IDENTIFICATION

A		VERRE GLASS	2MCX 2PCS
B		VERRE DU BAS BOTTOM GLASS	1MC 1PC
C		BARRE BAR	6MCX 6MC
D		BARRE BAR	4MCX 4PCS

IDENTIFICATION DES PIÈCES DE MONTAGE
HARDWARE IDENTIFICATION

1		Ø 1/4"X120MM	3MCX / 3PCS
2		Ø 1/4"X100MM	1MC / 1PC
3		Ø 1/4"X60MM	6MCX / 6PCS
4		Ø 1-1/8"X11MM	1MC / 1PC
5		Ø 34X8MM	16MCX / 16PCS
6		Ø 47X44MM	3MCX 3PCS
7		Ø 47X32MM	4MCX / 4PCS
8		Ø 1/4"X9MM	4MCX / 4PCS

ÉTAPE / STEP 1

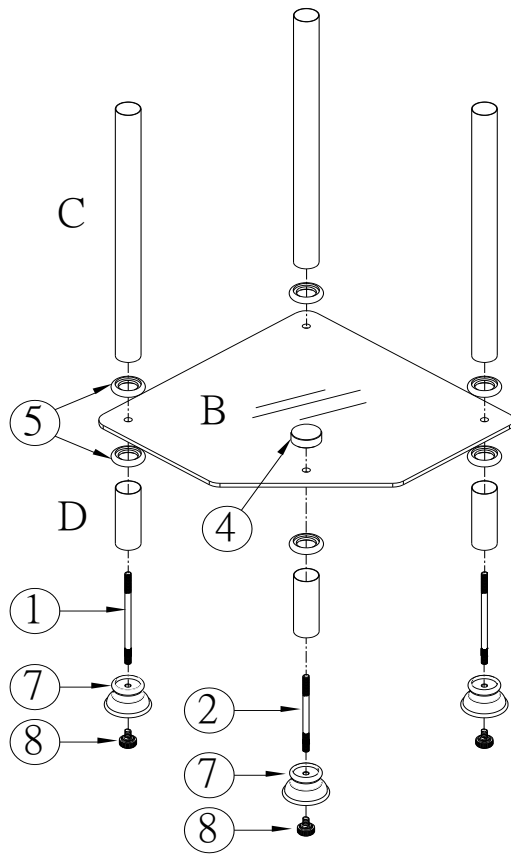

ÉTAPE / STEP 2

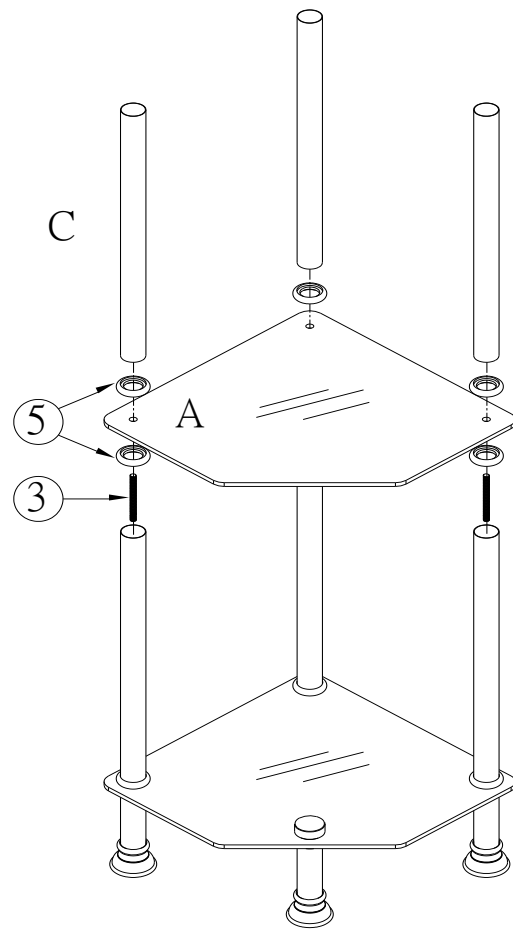

ÉTAPE / STEP 3

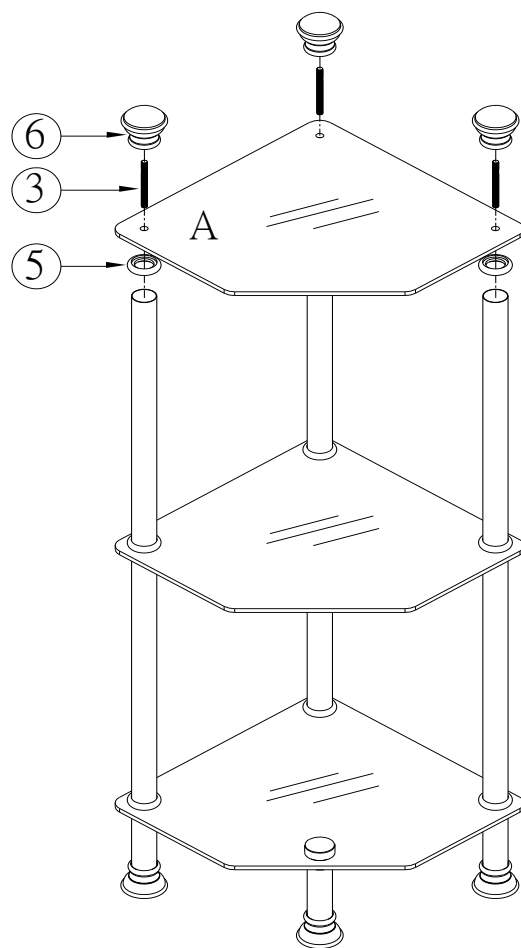

ÉTAPE / STEP 4

