



Meubles de Qualité à Prix Abordable
Affordable Quality Home Furniture

SUPPORT À VIN 16 BOUTEILLES CAPPUCINO
CAPPUCINO WINE RACK FOR 16 BOTTLES

I 3346

INSTRUCTIONS D'ASSEMBLAGE
ASSEMBLY INSTRUCTIONS

MONARCH SPECIALTIES INC.







POUR DE L'ASSISTANCE OU POUR COMMANDER
DES PIÈCES CONTACTEZ NOTRE DÉPARTEMENT
DE SERVICE À LA CLIENTÈLE.

FOR ASSISTANCE OR TO ORDER PARTS
CONTACT OUR CUSTOMER SERVICE DEPARTMENT

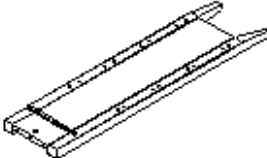
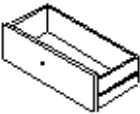





WWW.MONARCHSERVICE.COM

IDENTIFICATION DES PIÈCES**PARTS IDENTIFICATION**

1		PANNEAU DU DESSUS TOP PANEL	1 MC PC
2		PANNEAU CÔTÉ SIDE PANEL	2 MCX PCS
3		TIROIR DRAWER	1 MC PC
4		SUPPORT A BOUTEILLES BOTTLES SUPPORT	3 MCX PCS
5		SUPPORT A BOUTEILLES BOTTLES SUPPORT	3 MCX PCS
6		SUPPORT A BOUTEILLES BOTTLES SUPPORT	1 MC PC
7		SUPPORT A BOUTEILLES BOTTLES SUPPORT	1 MC PC

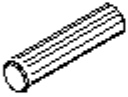
IDENTIFICATION DES PIÈCES DE MONTAGE

HARDWARE IDENTIFICATION

A		Ø 12 mm x 10.5 mm	6 MCX PCS
B		Ø 7mm x 33mm	6 MCX PCS
C		Ø 7mm x 25mm	4 MCX PCS
D		Ø 8mm x 30 mm	1 MC PC
E		Ø 4mm x 1/2"	2 MCX PCS
F		Ø 3mm x 300mm	1 MC PC
G		Ø 3mm x 10mm	2 MCX PCS
H		85mm x 35mm	1 MC PC

ÉTAPE / STEP 1

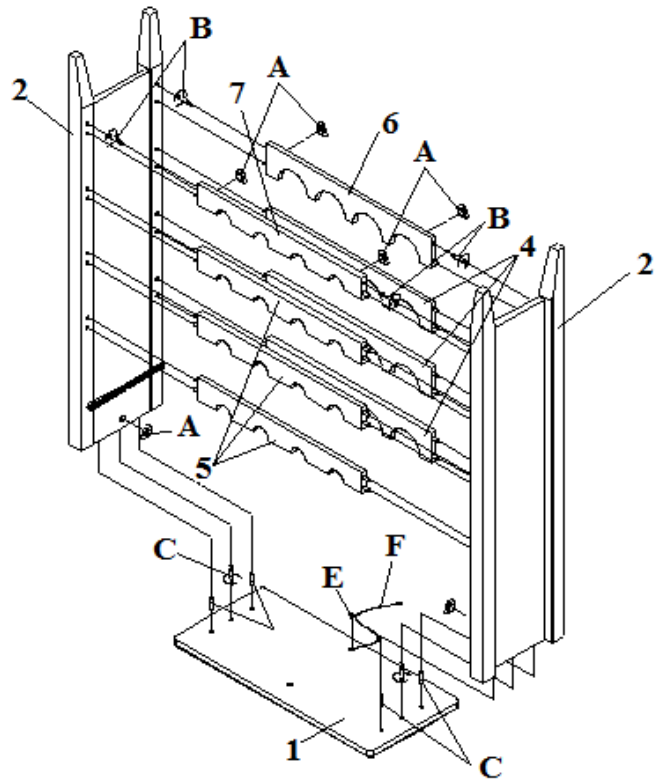

ÉTAPE / STEP 2

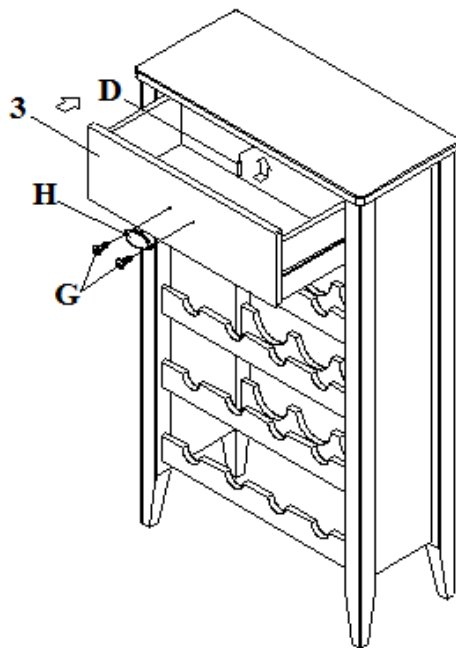

TERMINER / FINISH

