

# MONARCH SPECIALTIES INC.

*Meubles de Qualité à prix Abordable  
Affordable Quality Home Furniture*

ENS COIFFEUSE 2MCX MÉTAL ARGENT/NOIR  
BLACK/SILVER METAL 2PCS VANITY SET

## I 3092

INSTRUCTIONS D'ASSEMBLAGE  
ASSEMBLY INSTRUCTIONS

MONARCH SPECIALTIES INC.







POUR DE L'ASSISTANCE OU POUR COMMANDER  
DES PIÈCES CONTACTEZ NOTRE DÉPARTEMENT  
DE SERVICE À LA CLIENTÈLE.



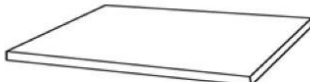

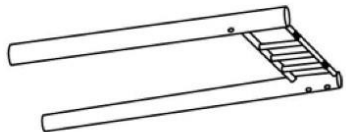
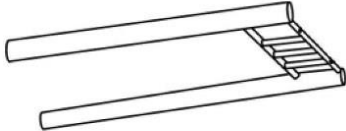
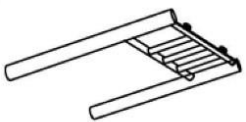
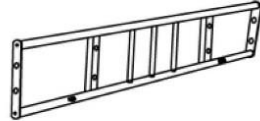

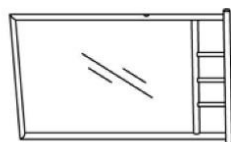
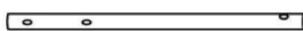
FOR ASSISTANCE OR TO ORDER PARTS  
CONTACT OUR CUSTOMER SERVICE DEPARTMENT

**[WWW.MONARCHSERVICE.COM](http://WWW.MONARCHSERVICE.COM)**

**IDENTIFICATION DES PIÈCES**  
**PARTS IDENTIFICATION**

1		DESSUS DE TABLE TABLE TOP	1MC/PC
2		TABLETTE SHELF	1MC/PC
3		SIÈGE COUSSINÉ CUSION SEAT	1MC/PC
4		PATTE DE TABLE GAUCHE LEFT TABLE LEG	1MC/PC
5		PATTE DE TABLE DROITE RIGHT TABLE LEG	1MC/PC
6		PATTE DE CHAISE CHAIR LEG	2MCX/PCS
7		BARRE DE SOUTIEN ARRIÈRE (TABLE) BACK LEG SUPPORT (TABLE)	1MC/PC
8		BARRE TRANSVERSALE CROSS BAR	1MC/PC
9		BARRE TRANSVERSALE (CHAISE) CROSS BAR (CHAIR)	2MCX/PCS
10		MIROIR MIRROR	1MC/PC
11		PATTE DUMIROIR MORROR LEG	2MCX/PCS

**IDENTIFICATION DES PIÈCES DE MONTAGE**  
**HARDWARE IDENTIFICATION**

A		Ø 1/4" X 25MM	4MCX/PCS
B		Ø 1/4" X 12MM	14MCX/PCS
C		Ø 4" X 12MM	8MCX/PCS
D		Ø 4" X 25MM	4MCX/PCS
E		Ø 1/4" X 30MM	2MCX/PCS
F		Ø 16	2MCX/PCS
G		CLÉ HEXAGONALE (4MM) ALLEN KEY (4MM)	1MC/PC

ÉTAPE / STEP 1

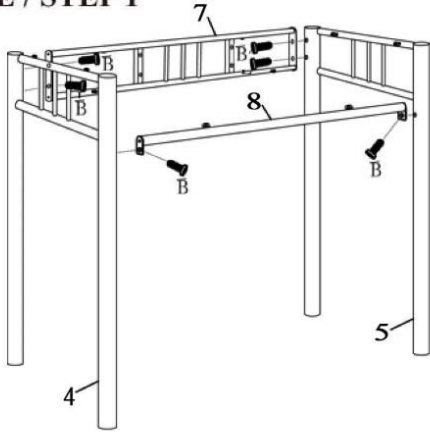

ÉTAPE / STEP 2

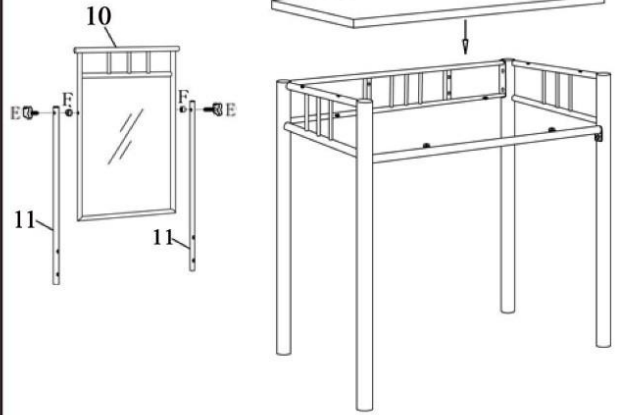

ÉTAPE / STEP 3

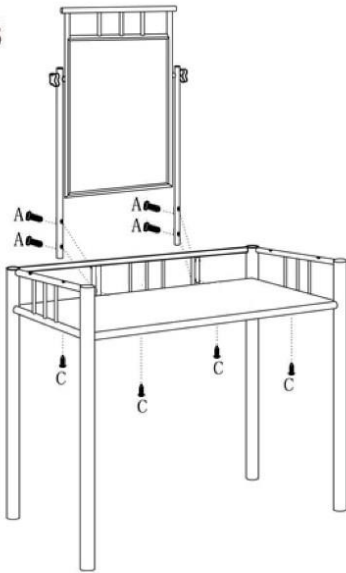

ÉTAPE / STEP 4

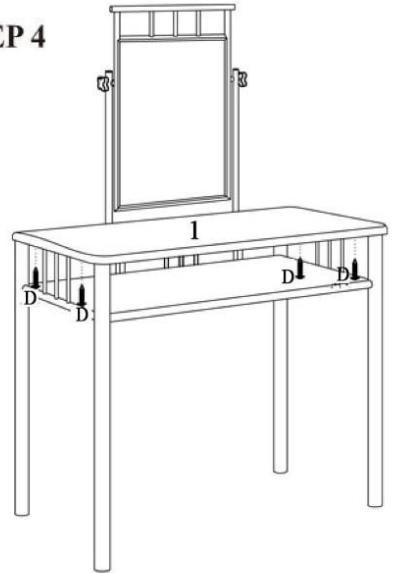

ÉTAPE / STEP 5

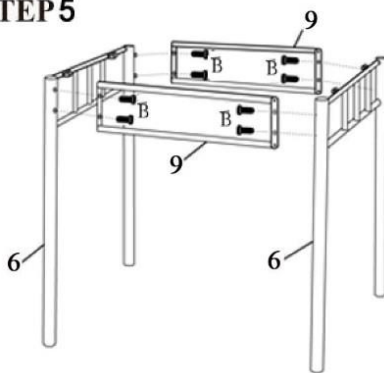

ÉTAPE / STEP 6

