



*Meubles de Qualité à Prix Abordable
Affordable Quality Home Furniture*

ÉTAGÈRE CONCEPT OUVERT 71"H CAPPUCCINO
CAPPUCCINO 71"H OPEN CONCEPT DISPLAY SHELF

I 2549

**INSTRUCTIONS D'ASSEMBLAGE
ASSEMBLY INSTRUCTIONS**

MONARCH SPECIALTIES INC.

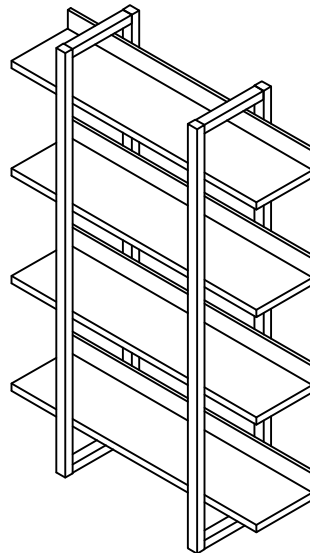



POUR DE L'ASSISTANCE OU POUR COMMANDER
DES PIÈCES CONTACTEZ NOTRE DÉPARTEMENT
DE SERVICE À LA CLIENTÈLE.





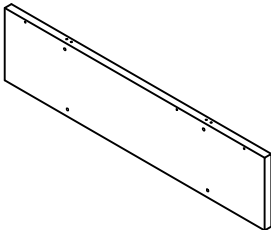
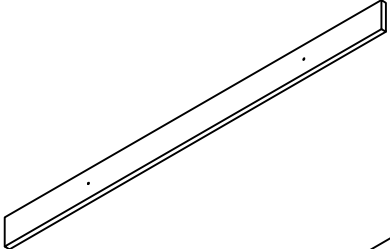
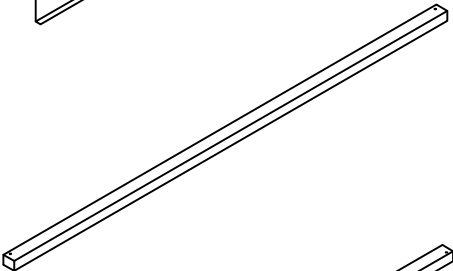
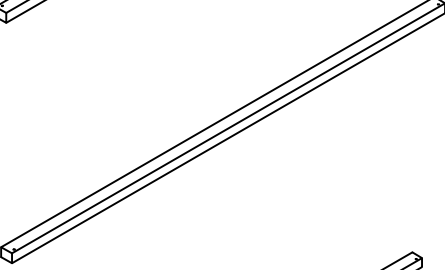
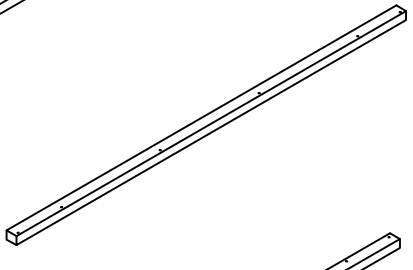
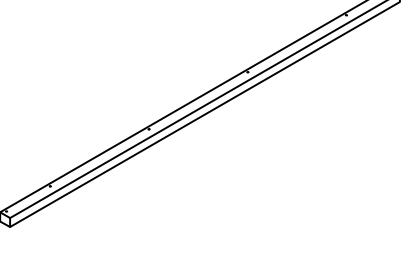





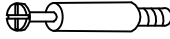

FOR ASSISTANCE OR TO ORDER PARTS
CONTACT OUR CUSTOMER SERVICE DEPARTMENT

WWW.MONARCHSERVICE.COM

IDENTIFICATION DES PIÈCES
PARTS IDENTIFICATION

(1)		TABLETTE SHELF	4PCS/MCX
(2)		BARRE TRANSVERSALE CROSS BAR	4PCS/MCX
(3)		PATTE AVANT GAUCHE FRONT-LEFT LEG	1PC/MC
(4)		PATTE AVANT DROITE FRONT-RIGHT LEG	1PC/MC
(5)		PATTE ARRIÈRE GAUCHE REAR-LEFT LEG	1PC/MC
(6)		PATTE ARRIÈRE DROITE REAR-RIGHT LEG	1PC/MC
(7)		BARRE TRANSVERSALE CROSS BAR	4PCS/MCX

IDENTIFICATION DES PIÈCES DE MONTAGE
HARDWARE IDENTIFICATION

A		L=29mm	8PCS/MCX
B		Ø15mm	8PCS/MCX
C		Ø8×25mm	48PCS/MCX
D		Ø20mm	4PCS/MCX
E		Ø13mm	8PCS/MCX
F		M6×85mm	16PCS/MCX
G		Ø10×15mm	16PCS/MCX
H		Ø4×35mm	8PCS/MCX
I		Ø4×50mm	16PCS/MCX
J		M4	1PC/MC
K		Ø16mm	4PCS/MCX
L			1PC/MC

ÉTAPE / STEP 1

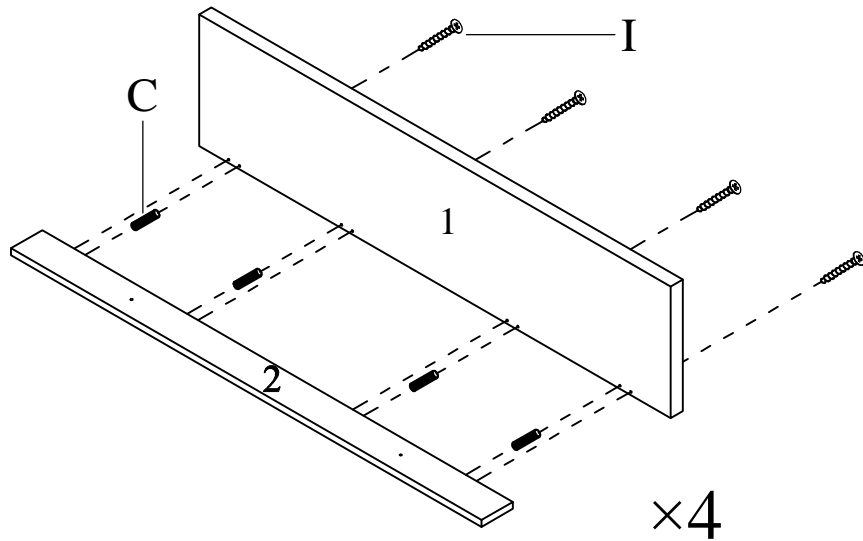

ÉTAPE / STEP 2

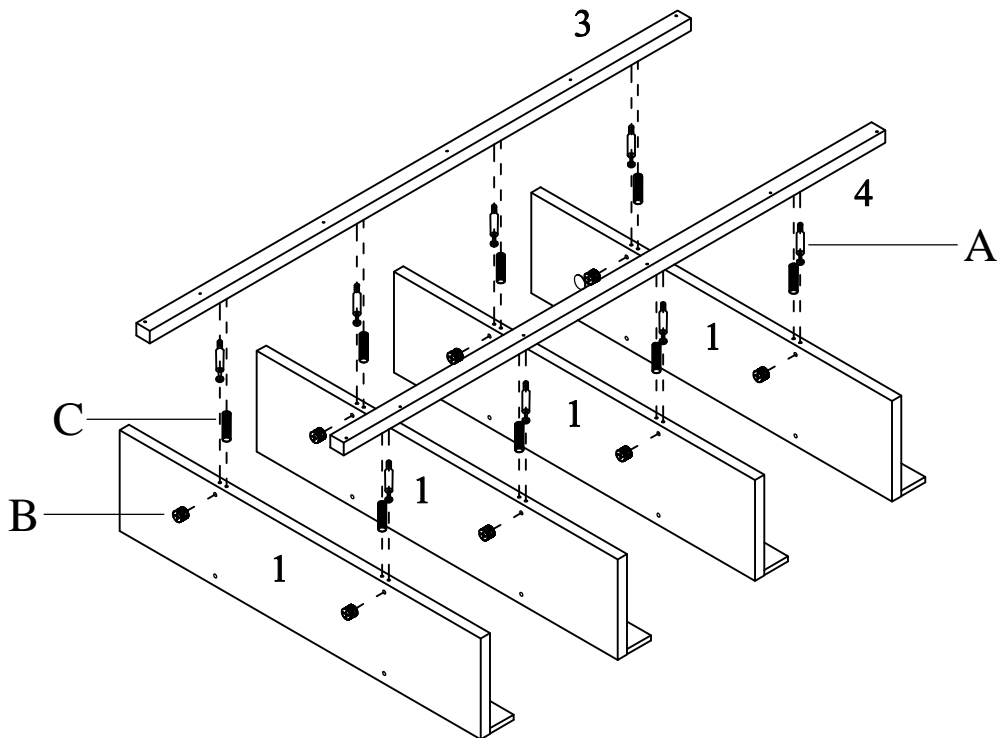

ÉTAPE / STEP 3

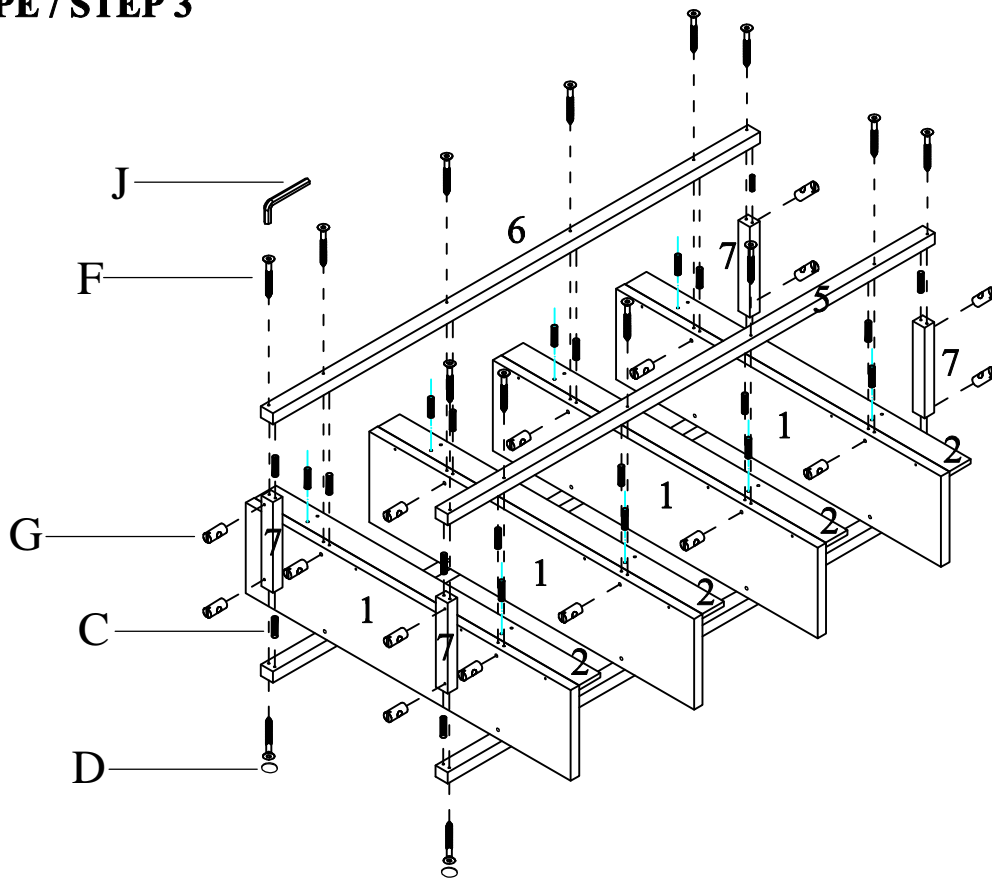

ÉTAPE / STEP 4

