

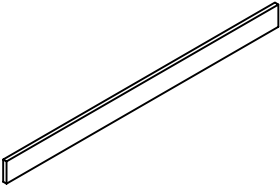

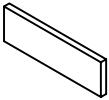

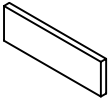

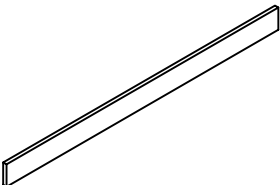
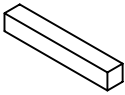
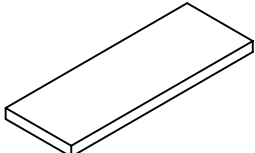

IDENTIFICATION DES PIÈCES
PARTS IDENTIFICATION

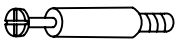
(1)		BARRE TRANSVERSALE CROSS BAR	2PCS/MCX
(2)		PATTE LEG	1PC/MC
(3)		PATTE LEG	1PC/MC
(4)		PATTE LEG	1PC/MC
(5)		PATTE LEG	1PC/MC
(6)		TABLETTE SHELF	2PCS/MCX
(7)		PANNEAU DU DESSOUS BOTTOM PANEL	1PC/MC
(8)		PANNEAU DE BASE BOTTOM BAR	2PCS/MCX





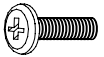
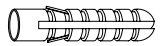
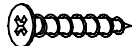

IDENTIFICATION DES PIÈCES
PARTS IDENTIFICATION

(9)		BARREAU DE BASE BOTTOM BAR	1PC/MC
(10)		PANNEAU DE BASE BOTTOM PANEL	1PC/MC
(11)		PANNEAU DE BASE BOTTOM PANEL	1PC/MC
(12)		BARREAU DE BASE BOTTOM BAR	1PC/MC
(13)		BARRE TRANSVERSALE CROSS BAR	2PCS/MCX
(14)		TABLETTE SHELF	2PCS/MCX

IDENTIFICATION DES PIÈCES DE MONTAGE
HARDWARE IDENTIFICATION

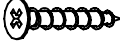
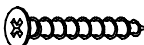
A		L=29mm	24PCS/MCX
B		Ø15mm	24PCS/MCX
C		Ø8x25mm	22PCS/MCX
D		Ø10x15mm	12PCS/MCX
E		Ø6x65mm	12PCS/MCX
F		M4mm	1PC/MC
G		Ø18mm	16PCS/MCX
H		Ø6x25mm	4PCS/MCX
I		Ø8x40mm	1PC/MC
J		Ø5x40mm	1PC/MC
K		Ø4x25mm	1PC/MC
L			1PC/MC

IDENTIFICATION DES PIÈCES DE MONTAGE
HARDWARE IDENTIFICATION

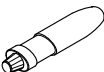
M		Ø6x45mm	6PCS/MCX
N		Ø10x11mm	6PCS/MCX
O		Ø4x35mm	4PCS/MCX
P		Ø4x45mm	2PCS/MCX
Q		50x35x35	2PCS/MCX
R		Ø4x16mm	12PCS/MCX
S		Ø16mm	8PCS/MCX
T			1PC/MC

ÉTAPE / STEP 1

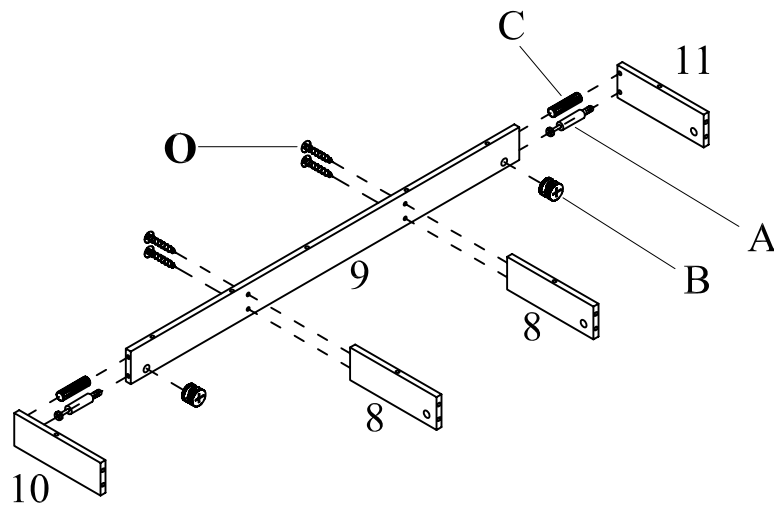

ÉTAPE / STEP 2

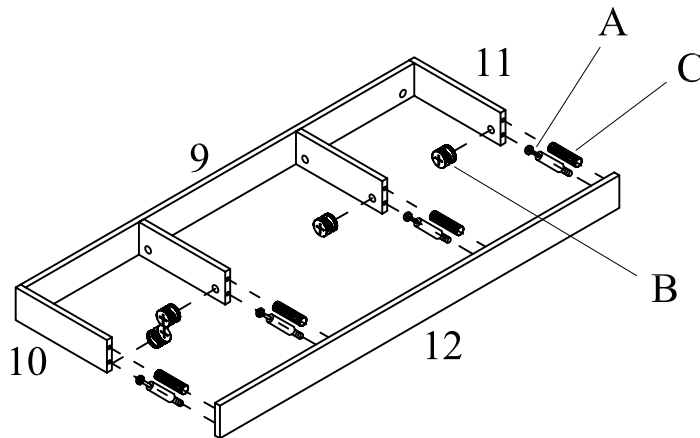

ÉTAPE / STEP 3

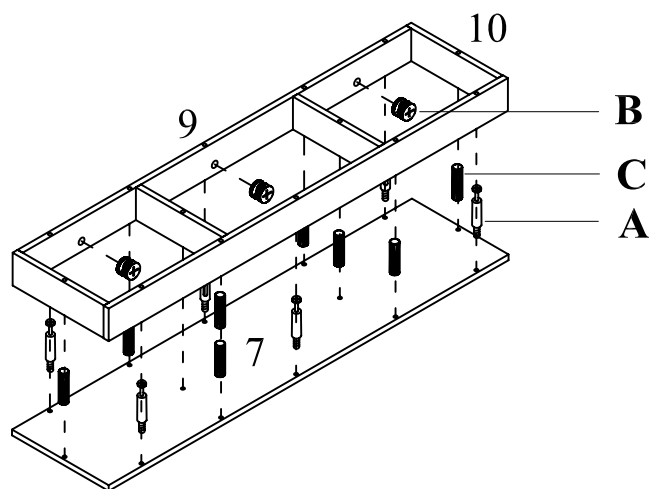

ÉTAPE / STEP 4

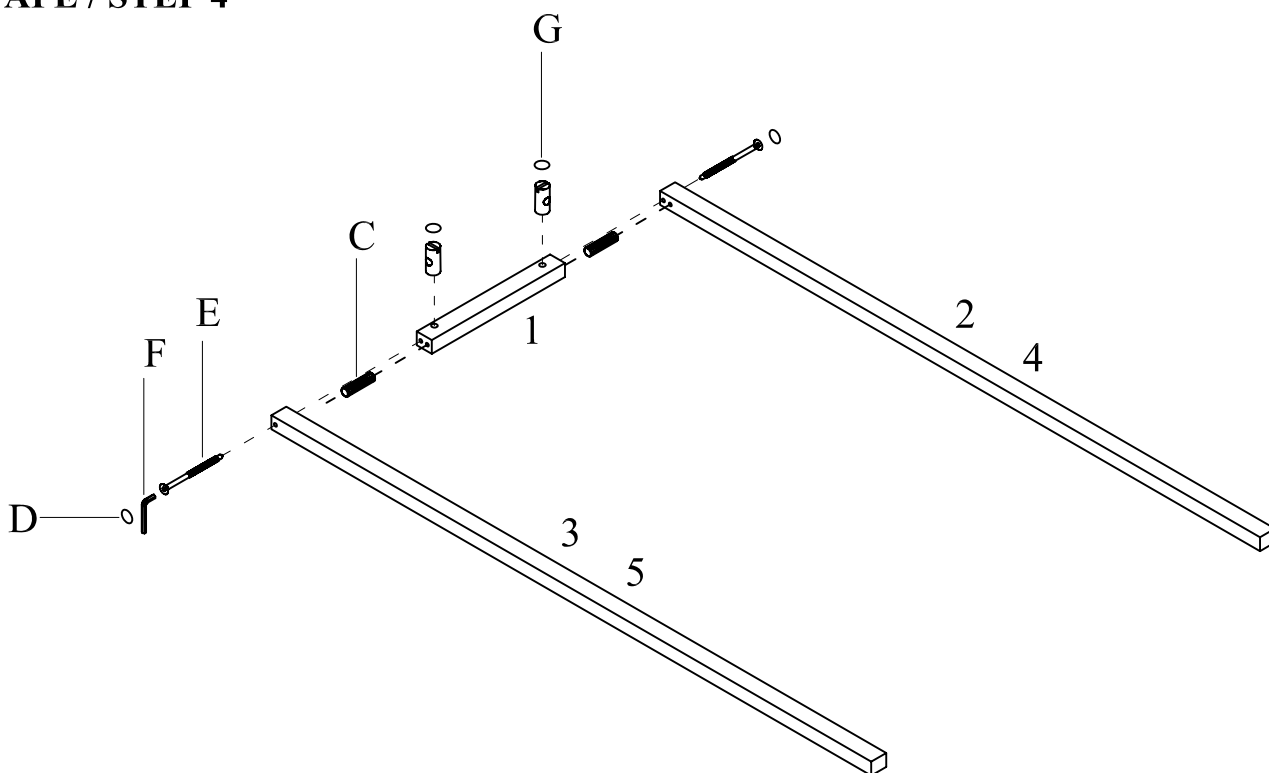

ÉTAPE / STEP 5

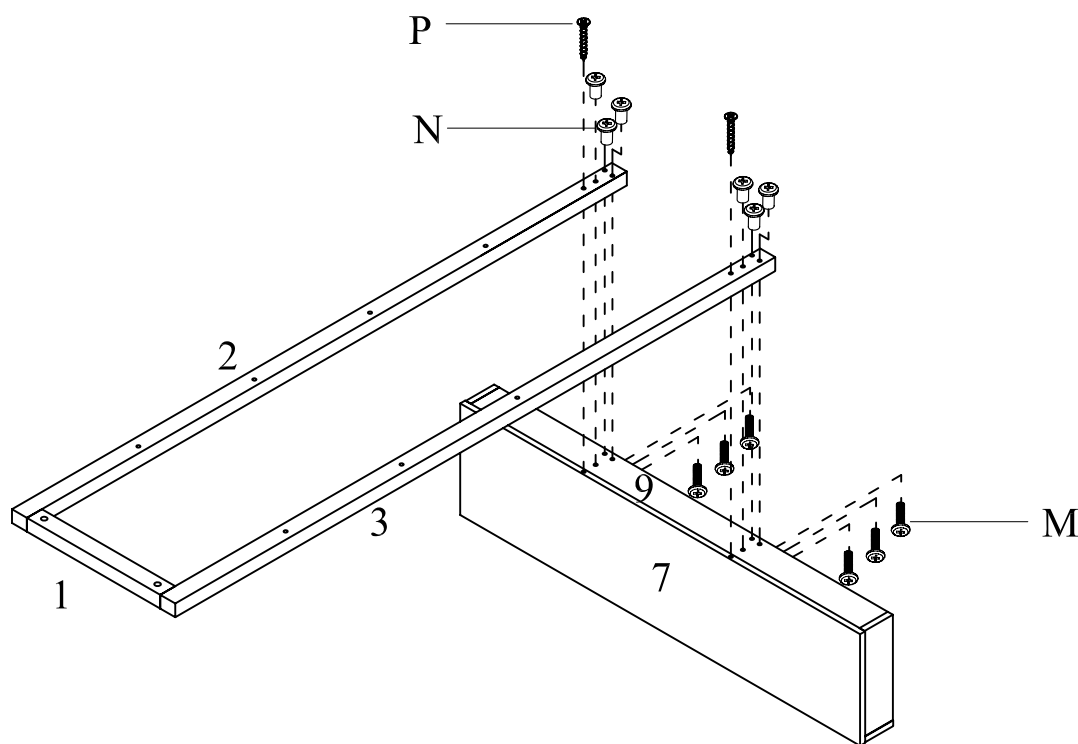

ÉTAPE / STEP 6

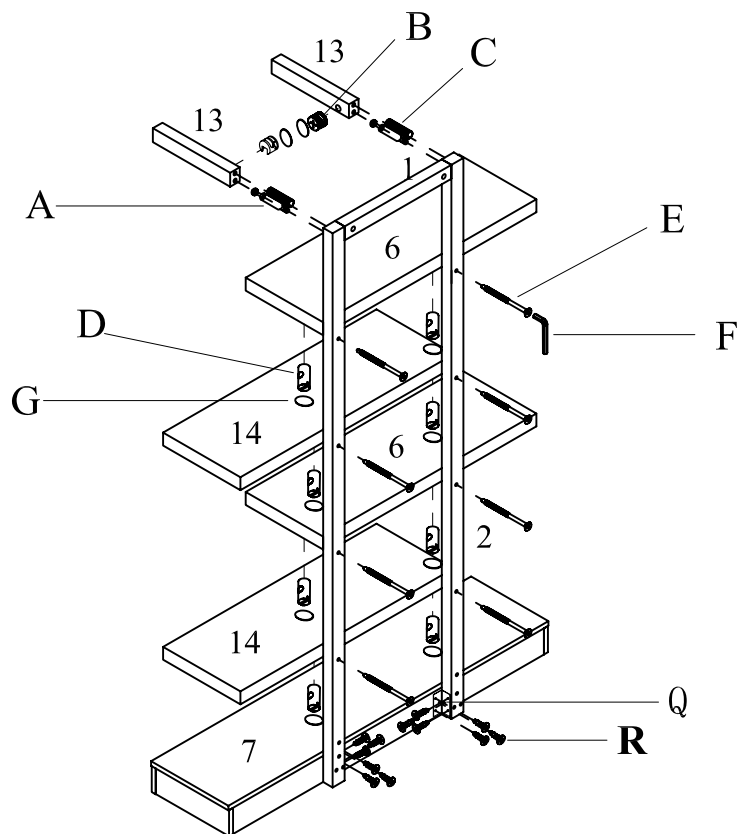

ÉTAPE / STEP 7

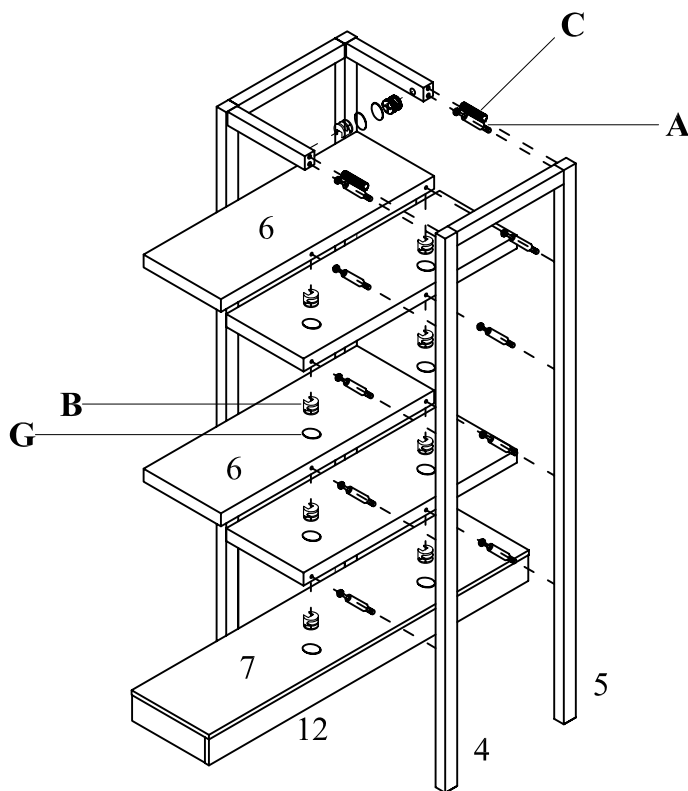

ÉTAPE / STEP 8

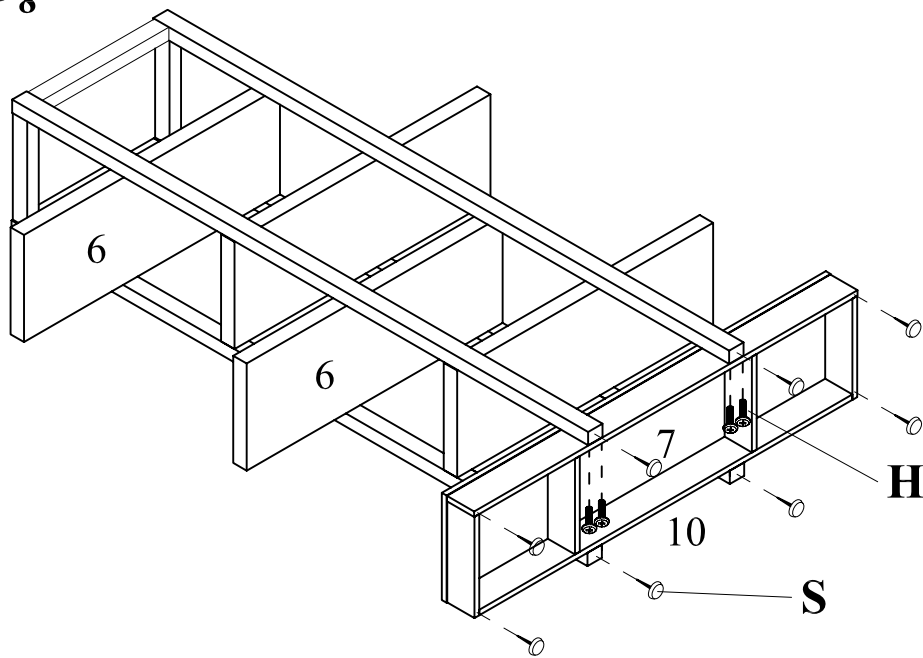

ÉTAPE / STEP 9

